



The sea urchin kinome: A first look

Cynthia A. Bradham^{a,*}, Kathy R. Foltz^b, Wendy S. Beane^a, Maria I. Arnone^c, Francesca Rizzo^c, James A. Coffman^d, Arcady Mushegian^e, Manisha Goel^e, Julia Morales^f, Anne-Marie Genevieve^g, François Lapraz^h, Anthony J. Robertson^d, Hemant Kelkarⁱ, Mariano Loza-Coll^j, Ian K. Townley^b, Michael Raisch^b, Michelle M. Roux^b, Thierry Lepage^h, Christian Gache^h, David R. McClay^a, Gerard Manning^k

^a DCMB Group, Duke University, Box 91000, Durham, NC 27708, USA

^b Department Molecular, Cellular and Developmental Biology, UCSB, Santa Barbara, CA, USA

^c Stazione Zoologica A, Dohrn, Napoli, Italy

^d Mount Desert Island Biological Laboratory, Salisbury Cove, ME, USA

^e Stowers Institute for Medical Research, Kansas City MO and Dept. of Microbiology, Kansas University Medical Center, Kansas City, KS, USA

^f Equipe Cycle cellulaire et Développement, UMR 7150 CNRS/UPMC, Station Biologique BP74, Roscoff, France

^g Observatoire Océanologique de Banyuls, Laboratoire Arago, CNRS-UMR7628/Université Pierre et Marie Curie (Paris 6), Banyuls-sur-Mer, France

^h Laboratory of Developmental Biology, UMR 7009, CNRS and Université Pierre and Marie Curie (Paris 6), Observatoire Océanologique, Villefranche-sur-Mer, France

ⁱ Center for Bioinformatics, Program in Molecular Biology and Biotechnology, University of North Carolina, Chapel Hill, NC, USA

^j Sunnybrook Research Institute and Department of Medical Biophysics, University of Toronto, Toronto, Ontario, Canada

^k Razavi-Newman Center for Bioinformatics, Salk Institute for Biological Studies, La Jolla, CA, USA

Received for publication 31 May 2006; revised 19 August 2006; accepted 22 August 2006

Abstract

This paper reports a preliminary *in silico* analysis of the sea urchin kinome. The predicted protein kinases in the sea urchin genome were identified, annotated and classified, according to both function and kinase domain taxonomy. The results show that the sea urchin kinome, consisting of 353 protein kinases, is closer to the *Drosophila* kinome (239) than the human kinome (518) with respect to total kinase number. However, the diversity of sea urchin kinases is surprisingly similar to humans, since the urchin kinome is missing only 4 of 186 human subfamilies, while *Drosophila* lacks 24. Thus, the sea urchin kinome combines the simplicity of a non-duplicated genome with the diversity of function and signaling previously considered to be vertebrate-specific. More than half of the sea urchin kinases are involved with signal transduction, and approximately 88% of the signaling kinases are expressed in the developing embryo. These results support the strength of this nonchordate deuterostome as a pivotal developmental and evolutionary model organism. © 2006 Elsevier Inc. All rights reserved.

Keywords: Kinase; Signal transduction; Genome; Kinome

Introduction

The role of reversible phosphorylation in enzymatic regulation was first discovered by Krebs and Fischer in the late 1950s, for which they later won the Nobel prize. Phosphorylation events are mediated by protein kinases, which transfer the gamma phosphate from ATP to their protein substrates. The protein kinases are now recognized as a crucial group of

enzymes that participate in and regulate all aspects of cellular function. The eukaryotic protein kinases (ePKs) are the largest superfamily of enzymes, comprising ~2.3% of genes in several genomes (Goldberg et al., 2006). Evolutionary analyses indicate that ePK-related kinases are found in bacteria and archaea, and this widespread distribution suggests that the ancestry of the catalytic kinase domain predates the divergence of these major domains of life (Leonard et al., 1998).

Functionally, protein kinases are at the core of most signal transduction. By modulating enzyme conformation and function, kinases control diverse processes including metabolism,

* Corresponding author. Fax: +1 919 613 8177.

E-mail address: cabrad@duke.edu (C.A. Bradham).

transcription, cell cycle progression, cytoskeletal rearrangement and cell movement, apoptosis, and differentiation. Kinase mutations that perturb signaling cascades are causally implicated in a range of diseases including cancer, inflammation, diabetes, and stroke (Manning and Caenepeel, 2005). An early discovery in oncogenesis was that the transforming factor of the Rous sarcoma virus is the protein kinase Src (Collett et al., 1978), while a few years later it was found that the tumor promoting activity of phorbol esters is a consequence of their potent activation of protein kinase C (PKC) (Castagna et al., 1982). The MAPK cascade is another clear example of the role of kinases in tumor progression, since inhibition of signaling through these kinases blocks ras-mediated transformation *in vitro* and tumorigenesis *in vivo* (Dudley et al., 1995; Sebolt-Leopold et al., 1999). The importance of kinases in oncogenesis is further demonstrated by the fact that the kinase domain is the most commonly represented domain among cancer genes, and is the class for which there is the clearest evidence of over-representation (Futreal et al., 2004).

Modulation of kinase activity can also have anti-inflammatory and immunosuppressive effects. In the early 1990s, the mechanism of action for two important immunosuppressive drugs was uncovered, and it was found that the first, cyclosporin A, functions by inhibiting a phosphatase (Liu et al., 1991), while the second, rapamycin, inhibits a kinase (Heitman et al., 1991). Thus, both drugs perturb the normal phosphorylation state of the cell. A few years later, it was realized that certain anti-inflammatory drugs suppress the expression of TNF α and IL-1 β by inhibiting a kinase later identified as p38 MAPK (Lee et al., 1994). Kinases are the most frequently targeted gene class in cancer therapeutics, and are second only to G protein-coupled receptors across all therapeutic areas (Cohen, 2002; Hopkins and Groom, 2002), illustrating their importance in both disease and pharmacology.

How many proteins are impacted by kinases? Early estimates, based on 2D gels, suggested that 30% of proteins are phosphorylated at any given time (Zolnierowicz and Bollen, 2000). Recent work shows that 30% of sea urchin egg proteins are phosphorylated prior to fertilization, while 66% are phosphorylated at two minutes post-fertilization (Roux et al., 2006). New approaches using mass spectrometry are opening the door to more direct measurements (Mann et al., 2002). In one study, 300 phosphorylation sites were detected in 200 proteins from the rat liver (Moser and White, 2006). In another, 2002 phosphorylation sites were identified in 967 proteins in HeLa cells using tandem mass spec (Beausoleil et al., 2004). Some proteins are clearly subject to multiple phosphorylations, and these data suggest that the number of proteins within the cell that are subject to phosphorylation may be much larger than previously appreciated. These methods are currently being improved and will eventually lead to the elucidation of the phosphoproteome.

The genomes of several species have now been sequenced, and the kinase complement ('kinome') from these genomes has been catalogued, classified and compared. These genomes include budding yeast, *Drosophila*, *C. elegans*, *Arabidopsis*, human, mouse and *Dictyostelium* (Caenepeel et al., 2004; Champion et al., 2004; Goldberg et al., 2006; Manning et al., 2002a; Manning

et al., 2002b). Comparison of these kinomes has provided insights into the evolution of kinase families. For example, yeast lack tyrosine kinases (TK) and tyrosine kinase-like (TKL) families, which is interpreted as the absence of the need for cell–cell communication and cooperation (Manning et al., 2002a). In contrast, the slime mold *Dictyostelium* possesses TKL but not TK kinases (Goldberg et al., 2006), suggesting that the TKL kinases are the forerunners of intercellular communication and signaling. Comparative analysis shows a wide divergence of kinase functions, with 75 distinct kinase classes predicted in the common ancestor of *Dictyostelium*, fungi and metazoans (Goldberg et al., 2006), and 46 still extant in all genomes. This ancient, universally conserved core includes kinases involved in cell cycle control (Wee, CDC2, CDC7, CDK7, CDK8, CRK7), mitosis (Bub, Nek, Aur, Scy1, PLK, Haspin), DNA damage control (RAD53, ATM, ATR), MAPK signaling (Erk, Ste7, Ste11, Ste20), lipid signaling (Akt, PDK) and energy homeostasis (Tor, AMPK, GCN2) (Goldberg et al., 2006).

The recently sequenced genome of the sea urchin *Strongylocentrotus purpuratus* provides a crucial data set to examine kinome and genome evolution. The sea urchin is an invertebrate deuterostome, evolutionarily closer to other deuterostomes, including vertebrates, than are protostomes such as *Drosophila* and *C. elegans*, and thus provides a glimpse into a very early step on the pathway to vertebrate evolution. The sea urchin is a well-studied developmental model organism: the larvae are morphologically simple, bilaterally symmetric, robust, and transparent. In addition, these embryos display regulative development, which is an important mechanistic parallel to the development of vertebrate embryos. Thus, the sea urchin embryo is positioned as the evolutionary link to vertebrate development, although the extent of molecular commonality has only now become measurable with the genomic sequence data. The purpose of this study was to annotate, catalog and classify the kinases within the sea urchin genome and to compare this preliminary kinome with that of other species in order to gain insight into this important evolutionary era. The results indicate that most of innovation and diversity associated with vertebrate kinases was already present in deuterostomes, and that the additional size and complexity of vertebrate kinomes are largely an elaboration of that innovation.

Methods

Kinase annotation

S. purpuratus genomic sequence and predicted gene models were provided by the Human Genome Sequencing Center at Baylor College of Medicine (BCM-HGSC) (Song et al., 2006; Zhang et al., 2006). Putative kinases were identified by searching both the protein predictions and the genomic assembly for similarity to protein kinase hidden Markov model (HMM) profiles. The full kinomes of human, *Drosophila* and *C. elegans* from KinBase (<http://kinase.com/kinbase/>) were used as BLAST probes of predicted sequences, and for homology-based gene prediction on scaffolds, using Gene Detective, a hardware-accelerated implementation of the genewise algorithm (Time Logic Inc., Carlsbad, CA). Several profile HMMs including the PFAM eukaryotic protein kinase model (PF00069; Bateman et al., 2004) and in-house models for several divergent kinase families were used by HMMSearch and Gene Detective to identify divergent kinases with poor similarity to any known kinases. Selected lipid

kinases were identified on a candidate basis (e.g. PI3K and DG family members) by subjecting homologous sequences from other species to BLAST analysis against the Baylor database (<http://www.hgsc.bcm.tmc.edu/blast/blast.cgi?organism=Spurpuratus>). Where possible, all predicted kinases were mapped back to predicted proteins (Glean3), though considerable differences in gene prediction accuracy remain. The high rate of heterozygous polymorphism and draft nature of the assembly produced many duplicate sequences which were eliminated manually; this was done conservatively, so a number of potential duplicates have been retained. The best human BLAST hit was determined for each annotated sequence; to corroborate the gene identity, the best urchin BLAST hit for each putative kinase gene was also determined. In the majority of cases, these best hits were bidirectional (Table S1).

Kinase expression

Embryonic kinase expression was evaluated by manually inspecting the tiling array data (Samanta et al., 2006), and in some cases EST data, for each putative kinase gene. Qualitative scores were assigned for each predicted kinase gene (Table S1).

Kinase classification

Kinases were classified according to the established taxonomy (Hanks and Hunter, 1995; Manning et al., 2002b), by bidirectional BLAST against metazoan kinomes (<http://kinase.com>), and by scoring against custom HMMs built from each defined subfamily. This taxonomy was corroborated by generating a phylogenetic tree of the ePK kinases (see below). A functional classification was also devised based on the literature and on the assumption of conservation of function.

Molecular phylogenetic analysis

Phylogenetic trees were produced for all predicted ePKs, and for selected protein kinase families to aid in gene identification. Homologous sequences from *Homo sapiens*, *Drosophila melanogaster*, *Gallus gallus*, *Xenopus tropicalis* and *Ciona intestinalis* were obtained from the Ensembl database (www.ensembl.org). Accession numbers for these sequences are provided in Table S2. Sequences were aligned using ClustalX (Thompson et al., 1997) and used to construct phylogenies using PAUP 4.0b10 (Swofford, 1998). Trees were produced using neighbor joining (NJ) with 5000 bootstrap replicates, using related kinases from the Ensembl database. For corroboration, each tree (except the ePK tree) was also generated with PAUP 4.0b10 using maximum parsimony (MP) with 1000 bootstrap replicates. For the ePK phylogeny, full-length kinase sequences were analyzed, and the resulting NJ tree was visualized and colored using HyperTree (Bingham and Sudarsanam, 2000) (<http://kinase.com/tools/HyperTree.html>). The initial tree highlighted a handful of classification errors which were subsequently corrected.

Results and discussion

Comprehensive identification of sea urchin protein kinases

Putative kinases were obtained by searching the predicted *S. purpuratus* genomic assembly and gene models for similarity to known protein and lipid kinases and protein kinase domain profiles. This produced a total of 353 protein kinases and 14 lipid kinases (Table S1). The kinase sequences are available as an interactive database on kinase.com (www.kinase.com/urchin/). Due to the draft nature of the genome assembly, and the high level of heterozygosity of the genome, many almost-identical partial or complete copies of kinases were found. Many of these were eliminated to keep a conservative kinase count, with the exception of some highly expanded families (see below). In addition, several kinases were split between multiple contigs.

These were combined when EST or close homolog data strongly indicated that they were the same gene. Many kinases likely remain as fragments based on homolog data, and so further improvements are likely as the genome assembly matures. Stops and frameshifts were seen in a few predicted kinases, but no attempt was made to distinguish genes from pseudogenes at this stage.

Sea urchin protein kinases were classified according to the established hierarchical clustering into groups and families (Hanks and Hunter, 1995; Manning et al., 2002b). This classification is based primarily on kinase domain sequence comparisons, thus reflecting a structural rather than pathway-based classification scheme. This classification was corroborated by a molecular phylogenetic analysis of the ePK (eukaryotic protein kinase) subset of the protein kinases (Fig. 1). The results show that the majority of the kinases are distributed into distinct classes as expected. The CK, RGC, CMGC, and AGC groups are present as single clusters, while the CAMK, TK, and TKL groups are each present as 2 separated clusters. One large branch is mixed, but composed mostly of Other. The failure of some family members to resolve to the expected branches is likely a reflection of the inherently imperfect nature of the heuristic methods used to generate phylogenies.

As with other kinomes, the urchin has several kinases with no family-level homologs in other organisms. Several of these genes cluster into a number of urchin-specific families. The largest of these, the urch family in the Other group, has 29 members (Fig. 2, Table S1). Of these, 21 are unique, while the remaining 8 are almost identical (>95% identity) to other family members (see footnotes, Table S1). These 8 additional genes may be artifacts due to sequencing or assembly errors; however, the presence of near-identical duplicates specifically in urchin-unique families likely has a biological underpinning. The urch family does not contain domains other than the kinase domain, and members are characterized by the lack of an arginine in the HRD motif (changed to [HCIM]ND) and a shortened activation loop, indicating that they are not activated by autophosphorylation (Johnson et al., 1996). Urchin-specific families also exist in the TK and TKL groups, and the urchin has a diverse expansion of FGFR-like predicted receptor tyrosine kinases, a phenomenon that was also seen in *Drosophila* and *C. elegans* kinomes, though the similarity between these various expansions is weak. An additional 7 unique kinases could not be classified even by group, and remain in the “Other: Unique” family.

Table 1 shows the distribution of the sea urchin kinases in comparison with the kinases from three other species. As expected, the urchin kinome appears intermediate between those of vertebrates and insects, both in terms of the classes of kinases present and in individual sequence alignments. Surprisingly, most of the innovations that were previously thought to be specific to vertebrates are present in urchins. Vertebrates contain 13 kinase subfamilies that are absent from both fly and worm genomes (Manning et al., 2002a). The urchin genome contains 9 of these (BCR, G11, DNAPK, HUNK, Trio, Lmr, Tie, RIPK, NKF3) and lacks only 4: the poorly characterized atypical kinases H11 and FASTK, the Axl tyrosine kinase receptor, and the uncharacterized family NKF5. Remarkably, the urchin has

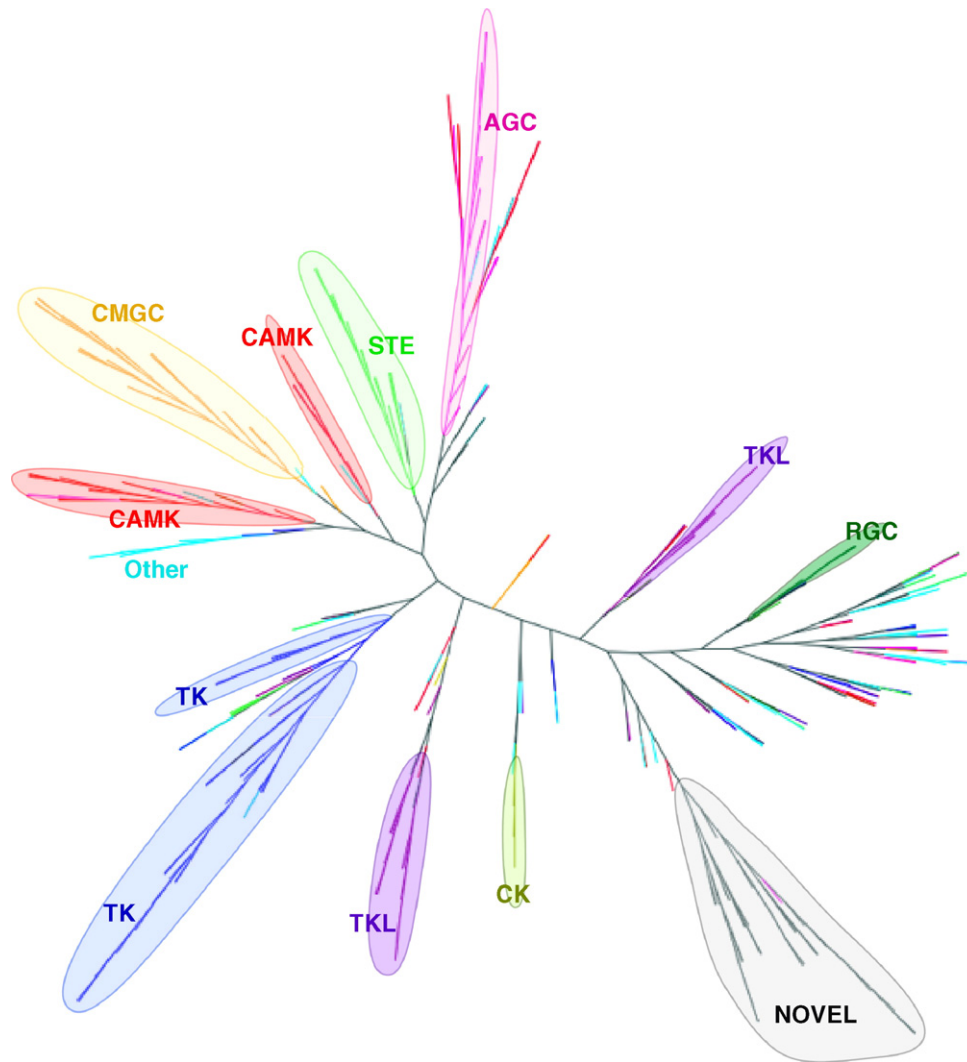

Fig. 1. A tree of the sea urchin ePK family. Phylogenetic analysis of the urchin ePK family is shown as an unrooted radial tree produced by neighbor joining (NJ) and visualized with HyperTree. The branches were colored according to taxonomy, as indicated by the labels. Highly divergent ePKs are indicated by black branches. The color blocks representing taxonomic classes were added manually. The classes depicted are AGC (PKA, PKG, PKC containing), CAMK (Ca/Calmodulin-type), CK1 (casein kinases), CMGC (CDK, MAPK, GSK, CDKL), STE (Ste7, 11, and 20 kinases), TK (tyrosine kinases), TKL (tyrosine kinase-like), RGC (receptor guanylyl cyclase) and Others (Hanks, 2003; Hanks and Hunter, 1995; Manning et al., 2002b). The aPK (atypical protein kinase) group contains proteins known to have kinase activity but which lack similarity to the eukaryotic protein kinase (ePK) domain (Manning et al., 2002b), and was excluded from this analysis.

lost no kinase classes, unlike fly (11 subfamilies lost), worm (7), or yeast (28), making it an excellent invertebrate model for the study of human kinase pathways (Fig. 3). Since the urchin did not experience the whole-genome duplications of vertebrates, its kinome is also highly nonredundant. With only 2/3 as many kinases as human (353/518), it lacks just 4 of the 186 human subfamilies; further, 131 urchin subfamilies have just a single member. Of those with multiple members, many reveal distinct vertebrate ortholog(s) for each urchin kinase, allowing a further fine-level classification based on deuterostome-wide conservation, as shown below for the MAPK pathway kinases. A small number of urchin kinases are significantly more similar to protostome than chordate homologs, suggesting for the first time that such kinases were specifically lost from the chordate lineage. These include the projectin, a muscle kinase homologous to titin, the Syk-family tyrosine kinase shark whose cha-

racteristic domain organization is not seen in vertebrates, and a number of insect-like receptor guanylate cyclases.

The identified kinases were also classified according to function. Table 2 shows the functional distribution, as well as embryonic expression percentages. The expression numbers are based on results from a massive tiling array reflecting the entire genome in 50 bp increments (separated by 10 bp spacers) that were probed with pooled embryonic cDNAs (Samanta et al., 2006). The results indicate that overall, the majority of kinases (76%) are expressed during embryonic development. The kinases with unknown function, which includes the novel urchin-specific kinases, are among the least well-expressed, suggesting that these genes serve mainly adult-specific functions. Unsurprisingly, the kinases associated with spermiogenesis were also poorly expressed. Since the embryo is clearly not generating sperm, it seems likely that either the expressed spermiogenesis

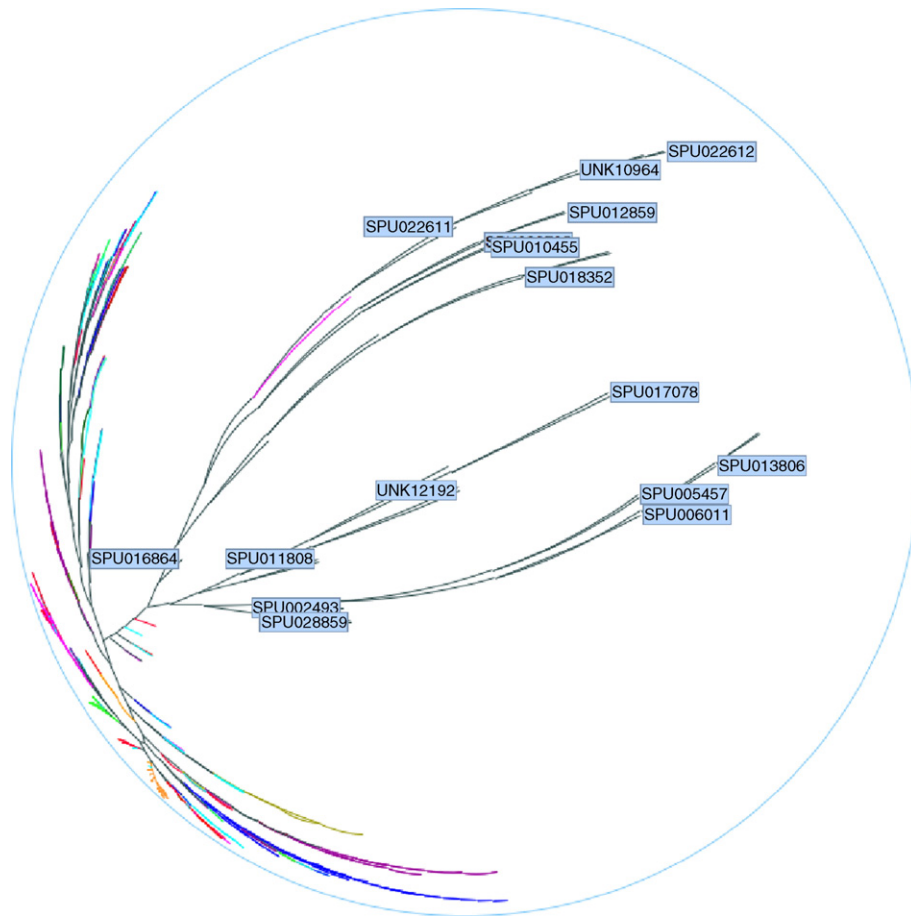

Fig. 2. Clustering of unidentified kinases. A screen shot is shown of the same phylogenetic tree as in Fig. 1, visualized hyperbolically and centered on the large branch ('Novel' in Fig. 1). The labeled branches correspond to the nonredundant divergent kinases classified as Other:urch.

genes have an alternative function, or that the expression results for those genes ($n=3$) are not correct. In addition, less than 50% of the apoptosis kinases were expressed. For the remaining groups, greater than 75% expression was detected. More than half of the identified kinases serve a signaling function, and the majority of these (88%) are expressed in the developing embryo. Table 3 shows the expression for the signaling subcategories. Of the 17 subcategories, only seven have less than 100% of their members expressed during embryonic development. Thus the

signaling kinase repertoire is highly represented in the developing embryo, particularly the receptor associated kinases, Src family kinases, MAPK cascades and targets, NF- κ B pathway kinases, PKCs and casein kinases. These data highlight the sea urchin as a rich model for the investigation of developmental signaling.

Specific examples of kinase families are addressed below. The receptor kinases (RTKs and STKRs) are the subject of a

Table 1
Taxonomic distribution of protein kinases in various species

Group	Yeast ^a	<i>Drosophila</i> ^a	Sea urchin	Human ^a
AGC	17	30	29	63
aPK	15	17	24	40
CAMK	21	32	50	74
CK1	4	10	6	12
CMGC	21	33	35	61
Other	38	45	92	83
Ste	14	18	21	47
TK	0	32	53	90
TKL	0	17	35	43
RGC	0	6	8	5
Total	130	239	353	518

^a Data from Manning et al., 2002b.

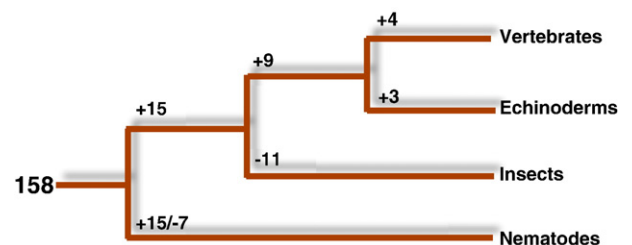

Fig. 3. Gain and loss of kinase subfamilies during metazoan evolution. Comparison of annotated kinomes (*C. elegans*, *C. briggsae*, *Drosophila*, mouse, human) suggests that an early metazoan had 162 distinct kinase subfamilies. Numbers on each branch indicate birth and loss of kinase subfamilies. Sea urchins share 9 subfamilies with vertebrates that are not seen in lower metazoans, lose none, and gain 3 urchin-specific classes. According to this classification, only four additional subfamilies were born within the chordate and vertebrate lineages.

Table 2
Functional distribution and embryonic expression of sea urchin protein and lipid kinases

Category	Total	Expressed	Percent expressed
Cytoskeletal	22	17	77.3
Apoptosis	5	2	40.0
Cell cycle	50	47	94.0
Metabolic	9	8	88.9
Endocytosis	7	6	85.7
Nuclear/Translational	18	14	77.8
Spermiogenesis	10	3	30.0
Unknown	48	15	31.3
Signaling	198	174	87.9
Total	365	278	76.2

separate manuscript (Lapraz et al., 2006), as are the kinases associated with cell cycle regulation (Fernandez-Guerra et al., 2006) and translational control (Morales et al., 2006).

Src family kinases

Src family kinases are present in all metazoans and regulate a variety of cellular processes including motility, proliferation, survival, and adhesion (Thomas and Brugge, 1997). Although Src kinases are well known as oncogenes and for their role in immune cell activation, members of this kinase family are also important in developing embryos (Stein et al., 1994). Src kinases are required for egg activation at fertilization, during gastrulation, and for cell fate specification in a variety of species (Bei et al., 2002; Livingston et al., 1998; Whitaker, 2006).

A number of genes related to *src* have been found in all metazoans based on their conserved SH2–SH3-kinase domain structure. In vertebrates, these fall into five families: Abl, Csk, Tec, SrcA and SrcB. The Abl tyrosine kinases are highly conserved across metazoans (Hughes, 1996), and are well-known

Table 3
Subcategories and embryonic expression of sea urchin signaling kinases

Signaling subcategory	Total	Expressed	Percent expressed
RTK/STKR	39	31	79.5
R signaling ^a	5	5	100.0
Src family	11	11	100.0
GTPase signaling	23	18	78.3
MAPK	7	7	100.0
MAPKK	6	6	100.0
MAPKKK	11	10	90.9
MAPKKKK	10	10	100.0
MAPK targets	11	11	100.0
NF-κB	5	5	100.0
Lipid	20	17	85.0
PKA	4	3	75.0
PKC	5	5	100.0
PKD	1	1	100.0
CAMK	8	7	87.5
Casein kinases	5	5	100.0
Misc. signaling	27	22	81.5
Total	198	174	87.9

^a Receptor-associated kinases, e.g. JAK.

inducers of leukemia when fused with the Bcr gene (Raitano et al., 1997). Csk is a Src regulator that phosphorylates Src on a C-terminal tyrosine, inhibiting its activity (Miller et al., 2000; Xu et al., 1999). Vertebrate Tec kinases are primarily expressed in hematopoietic lineages, endothelial cells, and the liver (Smith et al., 2001). Genes encoding SpAbl, SpCSK1, SpCSK2 and SpTec were found in the sea urchin genome (Fig. 4).

Within the Src family proper, distinct vertebrate and echinoderm expansions have occurred (Fig. 4). Vertebrates have the highly related SrcA (Src, Yes, Fyn, Fgr) and SrcB (Lck, Lyn, Hck, Blk) clusters, while urchins and other echinoderms have a distinct elaboration of src family kinases (SFKs). Seven SFKs were identified in the sea urchin genome, including a clear ortholog of the highly conserved Src family member Frk (Fig. 4), all of which are expressed during embryonic development (Table S1). The sea star *Asterina miniata* (Am), another echinoderm, has homologs of 3 of these, SFK1–3, which are expressed in eggs and throughout early embryogenesis (O'Neill et al., 2004). *S. purpuratus* SFK1, Frk, and SFK3 mRNAs are also detected in unfertilized eggs and early embryos

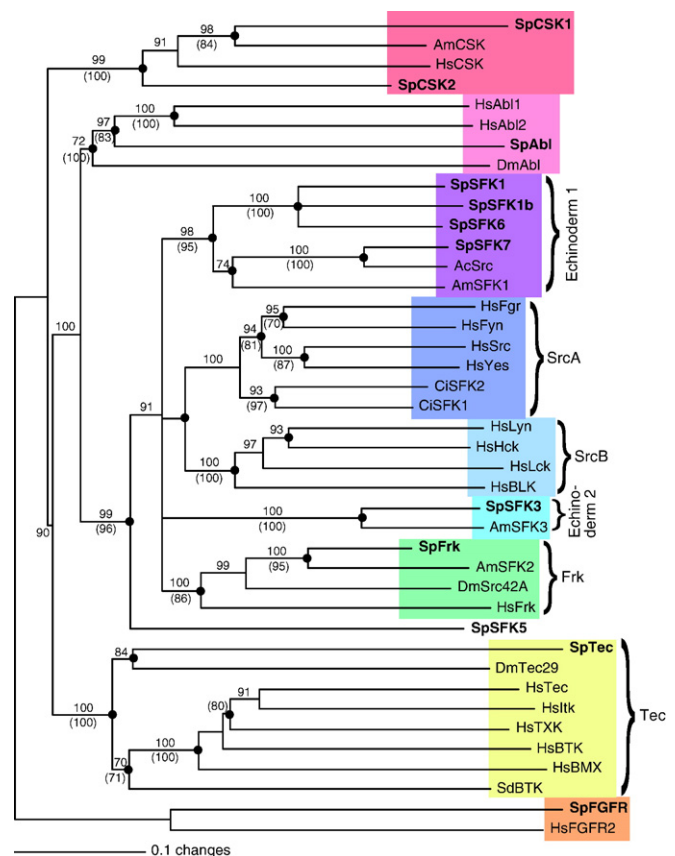

Fig. 4. Src family kinases. Phylogenetic analysis of Src family members from various species is shown as a distance tree produced by NJ. NJ bootstrap values are shown, along with corresponding maximum parsimony (MP) bootstrap values (in parentheses), for values >70. Nodes with topology preserved in both NJ and MP trees are indicated by dots. Hs and SpFGFRs were used as an outgroup. Species included are Sp: *Strongylocentrotus purpuratus*, Hs: *Homo sapiens*, Ci: *Ciona intestinalis*, Dm: *Drosophila melanogaster*, Sd: *Suberites domuncula* (sponge), Am: *Asterina miniata* (echinoderm), Ac: *Anthocidaris crassispina* (echinoderm).

(Giusti et al., 2003), suggesting potentially parallel functions with *A. miniata* proteins. A detailed functional analysis of the Src family kinases in egg activation is covered in (Roux et al., 2006).

This analysis of the Src family kinases shows a peculiarity not seen in the other families detailed below: an echinoderm-specific expansion, and an absence of clear orthologs for members of the Src family proper, although specific orthologs are present for the Abl, CSK and Tec families. Thus in this particular instance, we can observe that the birth of the Src families apparently occurred beginning in chordates, but not in echinoderms.

MAPK signaling

Mitogen-activated protein kinase (MAPK) signaling cascades are present in all eukaryotic cells, where they regulate various processes including proliferation, differentiation, migration and apoptosis. The classic Ras>Raf>MEK>ERK pathway has the distinction of being the singular pathway that contains the largest number of oncogenes (Boldt and Kolch, 2004). JNK signaling pathways are associated with stress and apoptosis (Boldt and Kolch, 2004), while the p38 cascade is important in inflammation and cancer (Bradham and McClay, 2006a). In general, MAPKs function in hierarchical tiers, such that MAPKs activate M2Ks, which activate M3Ks, which activate MAPKs (Boldt and Kolch, 2004; Pearson et al., 2001).

There is a large family of vertebrate MAPKs, whose 16 members include ERK1–5, ERK7, JNK1–3, p38 α – δ and NLK. Recent studies in sea urchins have shown a key role for ERK signaling in the ingression of the primary mesenchyme cells during gastrulation (Fernandez-Serra et al., 2004; Rottinger et al., 2004), and in the events surrounding fertilization and cell cycle re-entry (Kumano et al., 2001; Kumano and Foltz, 2003; Philipova et al., 2005a; Philipova et al., 2005b; Zhang et al., 2005). The p38 pathway is necessary for secondary axis specification in sea urchin embryos and is also invoked by UV-stress (Bonaventura et al., 2005; Bradham and McClay, 2006b). The sea urchin JNK pathway has been implicated in regulating larval skeletal patterning (Croce et al., 2006). Fig. 5A shows that, in the sea urchin, the three major MAPKs (ERK, JNK, and p38) are each represented by single genes, whereas in humans, each of these genes has undergone at least one duplication. Single homologs of the pan-metazoan Erk7 and NLK kinases are also found, along with single homologs of Erk3 and Erk5, kinases previously seen only in vertebrates. Hence the urchin defines two new classes of deuterostome MAPKs, and provides a good model for human MAPK signaling, with minimal redundancy.

A similar picture is seen in other levels of the MAPK pathway. While not previously divided into subfamilies, the urchin members of both Ste7 (MAP2K) and Ste11 (MAP3K) families are each orthologous to one or more human kinases, again defining new classes based on conservation between chordates and echinoderms, and including several kinases which lack protostome counterparts.

The M2Ks, frequently called MEKs, MAP2Ks or MKKs, are a family of dual specificity kinases, since they phosphorylate their target MAPKs on threonine and tyrosine. This is an uncommon property, and a recent study using both sea urchin and human cells has demonstrated that both of these phosphorylations are required for maximal ERK activation (Philipova and Whitaker, 2005). The M2K or STE7 family is typically a small family, and the members usually have quite specific substrates. For example, of the 16 human MAPKs, MEK1 phosphorylates only ERK 1 and 2, while in contrast, ERK1 and 2 phosphorylate 70 distinct downstream substrates (Boldt and Kolch, 2004). In the sea urchin, there are six identified M2Ks: 5 STE7 kinases and 1 kinase from the Other group, TOPK. Fig. 5B shows the phylogeny for this group. Like other metazoans, urchin has kinases specific for Erk (MEK1), JNK (MKK4, MKK7) and p38 (MKK3, TOPK) (Abe et al., 2000; Dougherty et al., 2005). Unlike protostomes, it has an MKK5, which correlates with the deuterostome-specific presence of its likely substrate, Erk5 (Pearson et al., 2001).

The M3Ks are a larger and more diverse group than the M2Ks, and they also have a broader substrate specificity (Boldt and Kolch, 2004; Pearson et al., 2001). M3Ks are members of the STE group (STE11 family), the TKL group (Raf and MLK families) and the Other group (Mos). In the STE11 group, single urchin orthologs of MEKK1, MEKK4, ASK (MEKK5) and MEKK15 were identified (Fig. 5C). SpMEKK2/3 is homologous to both MEKK2 and 3; MEKK3 is thought to activate the MKK5/ERK5 pathway (Pearson et al., 2001), thus it will be of interest to determine whether SpMEKK2/3 also has that ability. From the TKL group, Raf, MLK, LZK and TAK1 were each identified (Fig. 5C). TAK1 activates p38 MAPK via an alternate mechanism by inducing p38 to autophosphorylate (Ge et al., 2002). Finally, from the Other group, two Mos homologs were found. The likely relationships between these genes are depicted in Fig. 5D, based on what is known for vertebrate orthologs (Boldt and Kolch, 2004; Pearson et al., 2001). Cot and Nik are conspicuously absent from the sea urchin genome. Nik is an activator of NLK downstream from TAK1 (Pearson et al., 2001); it will be interesting to determine which protein fulfills that role in the sea urchin.

These MAPK cascade trees illustrate an unexpected finding, that in several families, the *Drosophila* sequence is more similar to human than is the urchin. To exclude the effect of gaps and prediction errors of draft urchin genes, we rebuilt several alignments with only high-confidence protein regions and found the effect to remain significant. Hence, despite the long generation time of urchins, it appears that a number of urchin proteins have diverged more than expected from their phylogenetic position. The urchin genome also provides direct orthologs for many of the MAPK components that are found in human but not in *Drosophila*. These include the MAPKs Erk3 and Erk5, the M2K MKK5, and the M3Ks MEKK1, and MEKK2/3. The particular example of MEKK2/3>MKK5>Erk5 demonstrates the emergence of a new pathway as a complete unit. The urchin provides an excellent model to study MAPK pathway component function in a biochemically tractable but simpler organism, as the urchin lacks redundant isoforms, but

possesses representatives of nearly all the human subfamilies. With the use of antisense and dominant negative approaches, it will be experimentally straightforward to determine the

developmental contribution of each of these kinases, which, aside from some of the MAPKs, are uncharacterized at the present time.

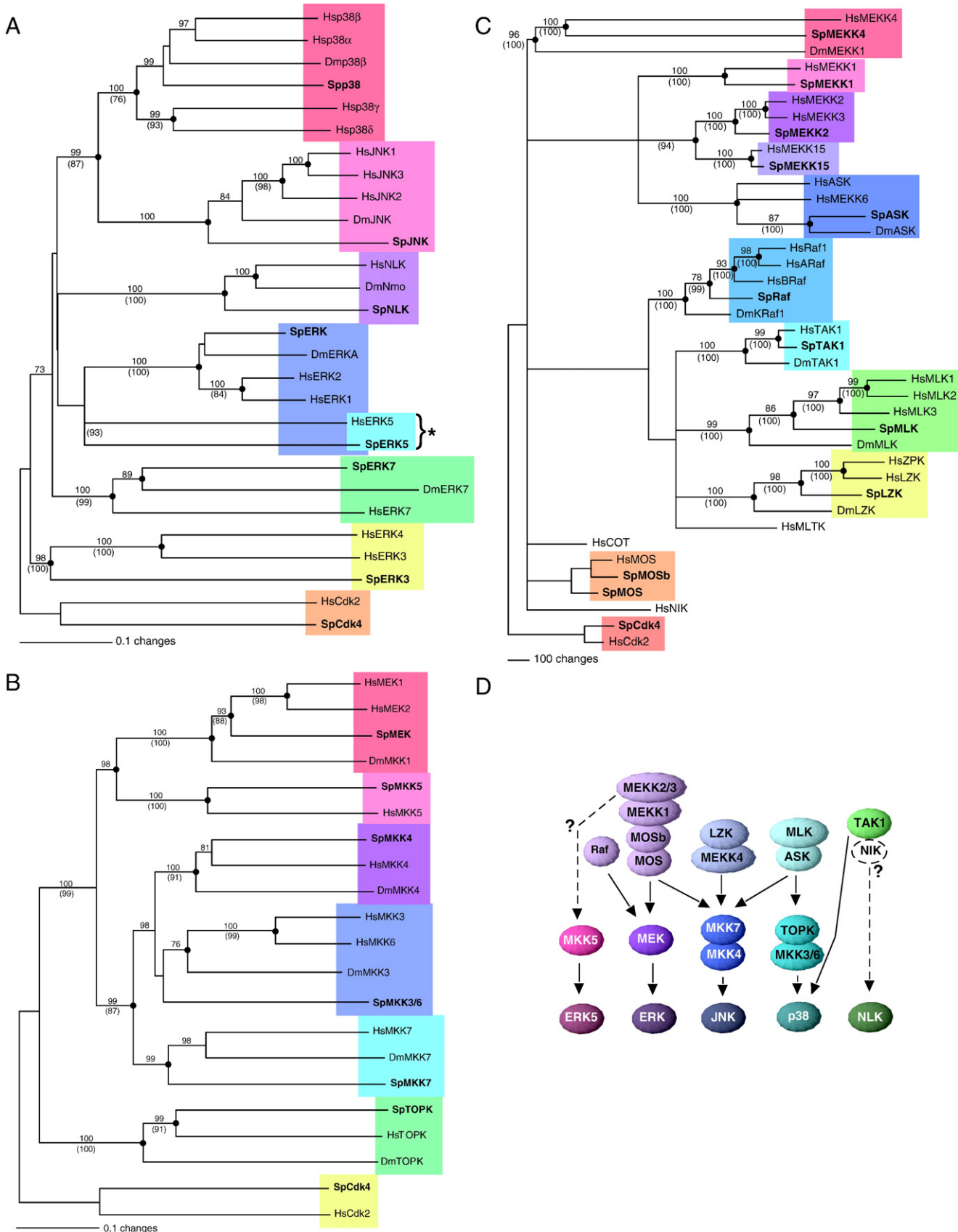

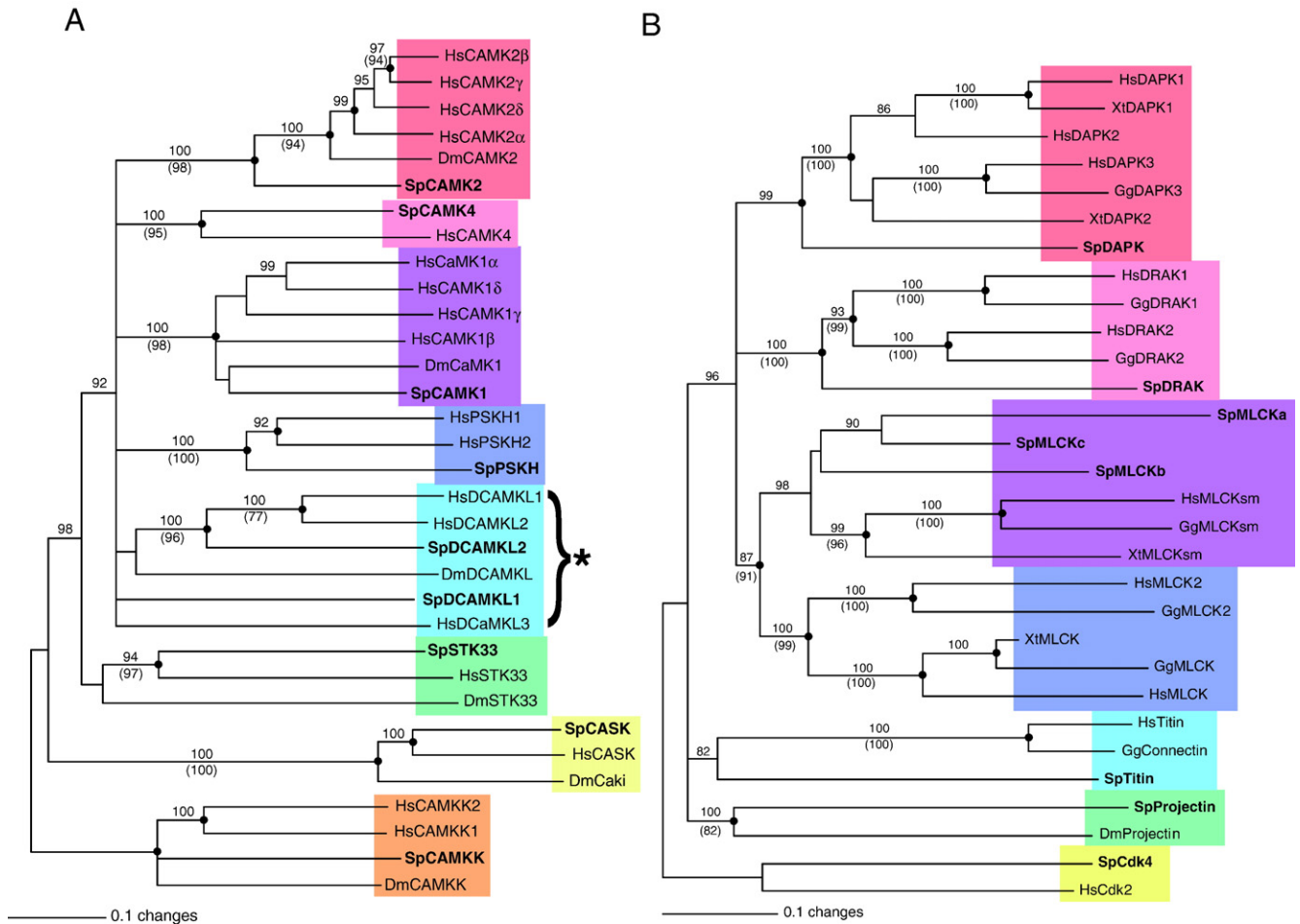

Fig. 6. Calmodulin-dependent gene families. Phylogenetic analysis of the CaMK gene family (A) and the MLCK family (B) is shown as NJ distance trees. Species and methods as in Fig. 4, except that the CAMKKs were used as the outgroup in panel A. The DCAMKL genes resolved as a single clade in the MP tree (starred bracket). Additional species used are Gg: *Gallus gallus*, and Xt: *Xenopus tropicalis*.

CAMK and MLCK

Calcium-mediated signaling plays crucial roles during fertilization and embryonic development as well as impacting a myriad of cellular activation, signaling, and transport events. A significant portion of calcium-mediated signaling is controlled by calmodulin-binding kinases. Calmodulin is a small protein that binds to calcium ions. The complex of Ca^{2+} and calmodulin binds to and activates other proteins, including the CAMK (calcium/calmodulin-dependent kinase) family members and MLCK (myosin light chain kinase). Interestingly, a transient increase in Ca^{2+} concentration leads to a more prolonged activation of these kinases due to the biochemistry underlying calmodulin-mediated activation (Soderling and Stull, 2001).

A vertebrate CAMK cascade has recently been described that consists of CAMKK, which activates CAMK1, which in turn

activates CAMK4. CAMK4 then modulates gene expression through the phosphorylation of transcription factors, and has been implicated in the mechanism underlying neural long-term potentiation, associated with learning (Soderling and Stull, 2001). The sea urchin genome contains single homologs of all three genes (Fig. 6A) including CAMK4, which was previously thought to be vertebrate-specific (Soderling and Stull, 2001). It will be intriguing to determine whether this pathway also plays a role in the urchin nervous system, which has recently received increasing attention (Burke et al., 2006; Nakajima et al., 2004; Yaguchi et al., 2006).

While the CAMK2 family is encoded by 4 genes in humans (Tombs et al., 2003), only a single CAMK2 gene was identified in the sea urchin genome (Fig. 6A). Sea urchin CAMK2 is required for nuclear envelope breakdown following fertilization (Baitinger et al., 1990). It will be an interesting challenge to

Fig. 5. MAPK pathway phylogenies. (A) Phylogenetic analysis of MAPKs from urchin (Sp), human (Hs) and *Drosophila* (Dm) are shown as a distance tree produced with NJ methods and corroborated with MP methods, as in Fig. 4. Hs and SpCdk5 were used as an outgroup. Hs and SpERK5 resolved as an independent clade in the MP tree with a bootstrap value of 93 (starred bracket). (B) Phylogenetic analysis of M2Ks, as in Fig. 4A. (C) Phylogenetic analysis of M3Ks, as in panel A, except a distance tree produced with MP is shown, and MP bootstrap values are shown along with NJ bootstraps (in parenthesis). (D) A schematic showing the predicted urchin MAPK pathway relationships. The absent NIK is shown as a dotted oval.

determine whether SpCAMK2 also plays a later developmental role in the nervous system, since in vertebrates it is a prominent hippocampal protein thought to functionally underlie synaptic plasticity (Braun and Schulman, 1995; Lisman, 1994). SpCAMK2 expression was not detected in the tiling array (Table S1), despite the clear experimental presence of the protein in urchin egg extracts (Baitinger et al., 1990). Although possibly due to a species difference, this discrepancy suggests that negative tiling array results should be interpreted with caution.

In addition to the CAMK proteins, several other related kinases are shown in Fig. 6A. Two DCAMKL (doublecortin and CAMK-like) genes were identified in the sea urchin genome. DCAMKL is a protein that regulates the microtubule cytoskeleton and is specifically expressed in the developing chick brain (Capes-Davis et al., 2005; Edelman et al., 2005; Lin et al., 2000). Sea urchin homologs of CASK, a protein that participates in cell adhesion (Lehtonen et al., 2005), and STK33, a kinase of unknown function (Mujica et al., 2005) were found. Finally, an urchin homolog of PSKH1 (protein serine kinase H1), required for maintenance of the Golgi apparatus (Brede et al., 2003), was also identified. As all of these proteins are expressed in the sea urchin embryo, yet most remain uncharacterized, it will be both intriguing and straightforward to

determine their developmental roles now that the genes have been identified. Again, the absence of redundancy will greatly simplify the experimental interpretations.

MLCK is a Ca^{2+} /calmodulin-dependent protein kinase whose only known substrate is the myosin II regulatory light chain. MLCK initiates contractions in smooth muscle and potentiates contraction in striated muscle (Soderling and Stull, 2001). Sea urchin MLCK has been studied in eggs where it participates in mitosis and cleavage (Chou and Rebhun, 1986; Shuster and Burgess, 1999). Remarkably, three distinct smooth muscle MLCK genes were identified in the sea urchin genome (Fig. 6B), although no homologs were identified for non-smooth muscle vertebrate MLCKs. This may reflect an absence of striated muscle types in the sea urchin (Elphick and Melarange, 2001). Sea urchin homologs were also identified for the related kinases DAPK, DRAK, Titin and projectin (Fig. 6B). DAPK (death associated protein kinase) and DRAK (DAPK-related apoptosis-inducing protein kinase) are both apoptosis-regulating kinases (Bialik and Kimchi, 2006; Sanjo et al., 1998). Titin is a structural component of cardiac muscle, while projectin is an elastic flight muscle component found in insects, but not in vertebrates (Bullard et al., 2006; Hoshijima, 2006).

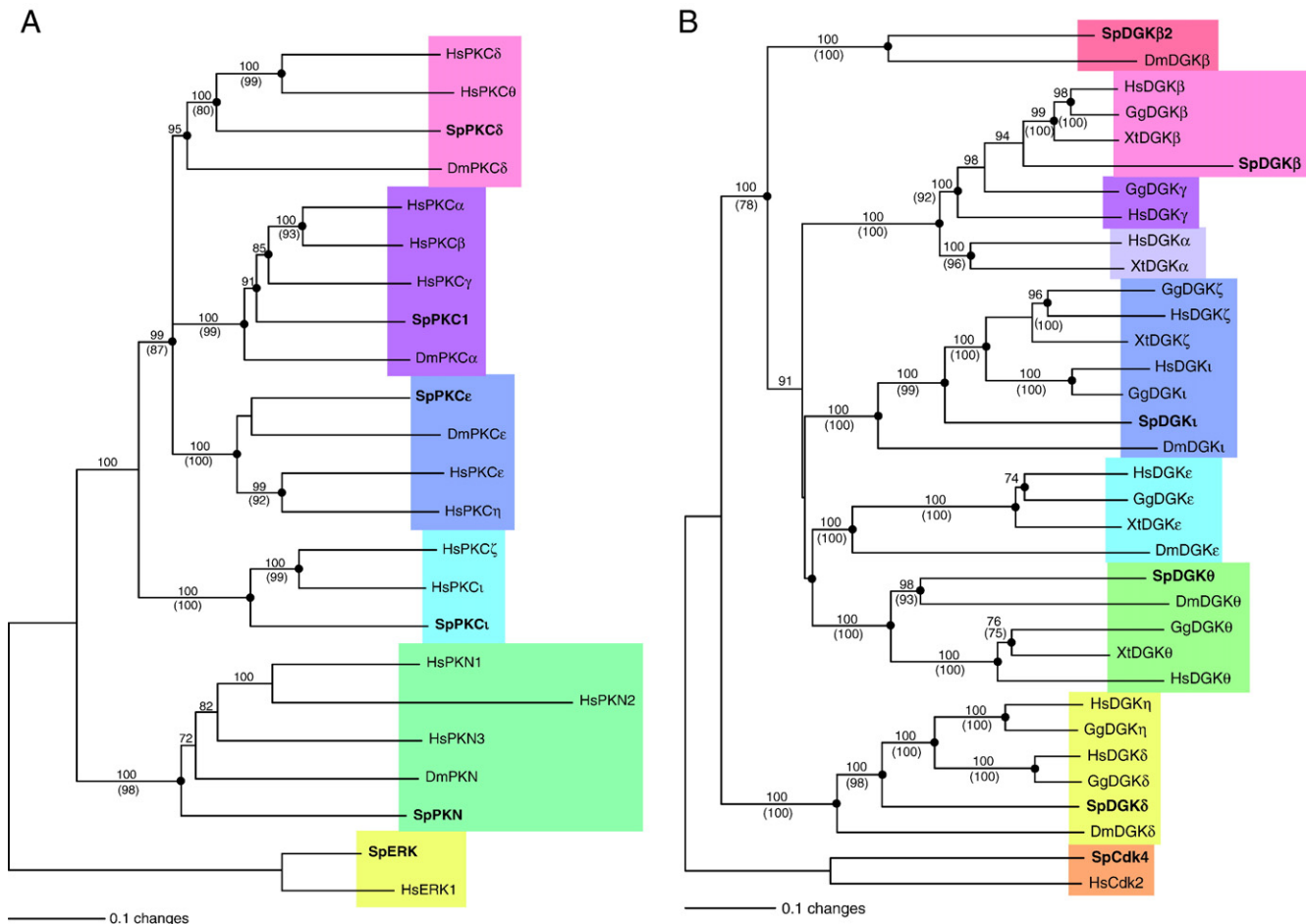

Fig. 7. PKC and DGK families. Phylogenetic analysis of the PKC (A) and DGK (B) gene families is shown as NJ distance trees. Species and methods are as in Figs. 4 and 6. Hs and Sp ERKs were used as the outgroup in panel A; Hs and Sp Cdk4 are the outgroup in panel B.

PKC and DGK

Protein kinase C (PKC) is a large family of proteins. The ‘conventional’ isoforms (α , β and γ) are sensitive to both Ca^{2+} and diacylglycerol (DAG) (Parker and Murray-Rust, 2004), and are commonly activated by engaged RTKs. Sea urchins possess a single conventional PKC gene, SpPKC1 (Fig. 7A), which plays critical roles in the induction of the oxidative burst in fertilized oocytes and in sperm nuclear decondensation following fertilization (Heinecke et al., 1990; Stephens et al., 2002). TPA, a known PKC inducer, was shown to expand the endomesoderm at the expense of the ectoderm during sea urchin embryogenesis (Livingston and Wilt, 1992), suggesting that the PKC participates in cell fate specification. More recently, PKC1 has been shown to play a required pro-survival role during urchin embryonic development (Dickey-Sims et al., 2005).

There are also ‘novel’ PKCs (δ , ϵ , η and θ) which are sensitive to DAG but not Ca^{2+} , and ‘atypical’ isoforms (ζ and ι) that are insensitive to both (Parker and Murray-Rust, 2004). Knockout studies in mice have shown that PKC β , γ , δ and ζ are not individually required for embryonic development, although knockout animals display various non-lethal defects (Parker and Murray-Rust, 2004). The sea urchin has two novel PKCs, δ and ϵ , and one atypical PKC, ι , similar to the array in *Drosophila* (Fig. 7A). It will be of interest to determine the developmental requirement for these as yet uncharacterized urchin PKCs, both individually and in combinations.

Diacylglycerol kinase (DGK), a representative of the lipid kinases, phosphorylates DAG to produce phosphatidic acid. Thus DGK activity is inhibitory to DAG-dependent enzymes such as the conventional and novel PKCs (Topham, 2006). This family of genes is widely expressed in mammals, though each isoform has a distinct expression profile. DGKs play prominent roles in neuronal transmission, lymphocyte signaling, and carcinogenesis (Topham, 2006). Although nine mammalian DKG genes exist, only five urchin DGK genes were found: two SpDGK β s, and single SpDGK δ , θ , and ι (Fig. 7B). DGKs are associated with neural development in both flies and mammals (Adachi et al., 2005; Harden et al., 1993), suggesting that sea urchin DGKs may also play neural-specific developmental roles. The identification of these genes is an important first step toward elucidating their functions.

Casein kinases

In 1954, Burnett and Kennedy discovered the first protein kinase activity, based on the ability of rat liver extract to phosphorylate casein (Burnett and Kennedy, 1954). While there are 7 human and 8 *Drosophila* CK1 genes, this family has been expanded to 87 members in *C. elegans* (Manning et al., 2002b; Morrison et al., 2000; Plowman et al., 1999). Four sea urchin CK1 genes have been identified, SpCK1 α 1 and 2, γ and ϵ (Fig. 8). Several isoforms of CK1 phosphorylate β -catenin, implicating CK1 in Wnt and Hedgehog signaling (Marin et al., 2003; Price, 2006), which are crucial developmental pathways used repetitively during axial and cell fate specification. Thus the SpCK1 genes are quite likely to prove to be developmentally important.

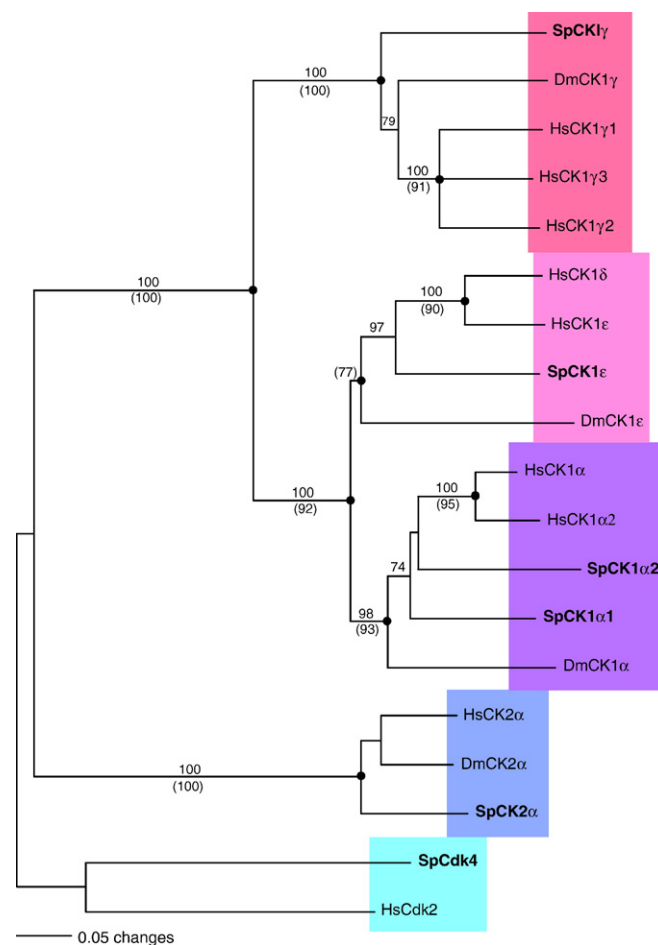

Fig. 8. Casein kinase family. Phylogenetic analysis of the CK gene family is shown as an NJ distance tree. Species and methods are as in Fig. 4. Hs and SpCdk2 were used as the outgroup.

CK2 forms tetrameric structures composed of two catalytic and two regulatory subunits. CK2 is typically constitutively active, and has been reported to target hundreds of substrates (Litchfield, 2003). Thus, it has been proposed that this kinase contributes to the phosphoproteome more than any other (Meggio and Pinna, 2003). In the sea urchin genome, a single CK2 α homolog was identified (Fig. 8). In addition, one SpCK2 β regulatory subunit was found (SPU_016763). In urchin embryos, CK2 inhibitors block the transition from turning to hatching prior to gastrulation (Delalande et al., 1999), suggesting that SpCK2 plays an early role in embryonic development. Identification of these genes will permit a direct investigation of their function during embryogenesis.

Conclusions

This initial foray into analyzing the sea urchin kinome shows that it is positioned midway between the *Drosophila* and human kinomes, although the repertoire of genes present in the sea urchin is comparable to humans and is largely nonredundant. In addition, the vast majority of the signaling kinases are expressed in the developing embryo. This will be a tremendous boon for functional embryonic studies. Sea urchins and humans share

numerous gene families that are absent from protostomes, including 20 kinase subfamilies absent from *Drosophila*, and many more direct 1:1 homologs that are not distinguished by the current classification scheme. Thus the urchin possesses the diversity of the vertebrate kinome without its complexity. Together, these findings show that the sea urchin is a rich model for the investigation of vertebrate developmental signaling and evolution.

Acknowledgments

We thank James Balhoff and Simon Wu for expertise and advice concerning phylogeny construction and evaluation. We also thank Evangeline Reynolds for assistance with sequence compilation, and Nikki Adams, Robert Burke, Christine Byrum, Jenifer Croce, Mark Hann, Matthew Hoffman, Richard Hynes, Shugang Liang, Dan Mellot, Gary Moy, Ryan Range, Eric Rottinger, Katya Voronina, Charlie Whittaker, Karen Wilson, and Ronghui Xu for annotations. Supported by NIH grants 61464, HD14483, DOE grant DE-FG02-03ER63584, and by the Razavi-Newman Center for Bioinformatics and NCI core grant P30 CA014195.

Appendix A. Supplementary data

Supplementary data associated with this article can be found, in the online version, at doi:10.1016/j.ydbio.2006.08.074.

References

- Abe, Y., Matsumoto, S., Kito, K., Ueda, N., 2000. Cloning and expression of a novel MAPKK-like protein kinase, lymphokine-activated killer T-cell-originated protein kinase, specifically expressed in the testis and activated lymphoid cells. *J. Biol. Chem.* 275, 21525–21531.
- Adachi, N., Oyasu, M., Taniguchi, T., Yamaguchi, Y., Takenaka, R., Shirai, Y., Saito, N., 2005. Immunocytochemical localization of a neuron-specific diacylglycerol kinase beta and gamma in the developing rat brain. *Brain Res. Mol. Brain Res.* 139, 288–299.
- Baitinger, C., Alderton, J., Poenie, M., Schulman, H., Steinhardt, R.A., 1990. Multifunctional Ca²⁺/calmodulin-dependent protein kinase is necessary for nuclear envelope breakdown. *J. Cell Biol.* 111, 1763–1773.
- Bateman, A., Coin, L., Durbin, R., Finn, R.D., Hollich, V., Griffiths-Jones, S., Khanna, A., Marshall, M., Moxon, S., Sonnhammer, E.L., Studholme, D.J., Yeats, C., Eddy, S.R., 2004. The Pfam protein families database. *Nucleic Acids Res.* 32, D138–D141.
- Beausoleil, S.A., Jedrychowski, M., Schwartz, D., Elias, J.E., Villen, J., Li, J., Cohn, M.A., Cantley, L.C., Gygi, S.P., 2004. Large-scale characterization of HeLa cell nuclear phosphoproteins. *Proc. Natl. Acad. Sci. U. S. A.* 101, 12130–12135.
- Bei, Y., Hogan, J., Berkowitz, L.A., Soto, M., Rocheleau, C.E., Pang, K.M., Collins, J., Mello, C.C., 2002. SRC-1 and Wnt signaling act together to specify endoderm and to control cleavage orientation in early *C. elegans* embryos. *Dev. Cell.* 3, 113–125.
- Bialik, S., Kimchi, A., 2006. The death-associated protein kinases: structure, function, and beyond. *Annu. Rev. Biochem.*
- Bingham, J., Sudarsanam, S., 2000. Visualizing large hierarchical clusters in hyperbolic space. *Bioinformatics* 16, 660–661.
- Boldt, S., Kolch, W., 2004. Targeting MAPK signalling: Prometheus' fire or Pandora's box? *Curr. Pharm. Des.* 10, 1885–1905.
- Bonaventura, R., Poma, V., Costa, C., Matranga, V., 2005. UVB radiation prevents skeleton growth and stimulates the expression of stress markers in sea urchin embryos. *Biochem. Biophys. Res. Commun.* 328, 150–157.
- Bradham, C., McClay, D.R., 2006a. p38 MAPK in development and cancer. *Cell Cycle* 5, 824–828.
- Bradham, C.A., McClay, D.R., 2006b. p38 MAPK is essential for secondary axis specification and patterning in sea urchin embryos. *Development* 133, 21–32.
- Braun, A.P., Schulman, H., 1995. The multifunctional calcium/calmodulin-dependent protein kinase: from form to function. *Annu. Rev. Physiol.* 57, 417–445.
- Brede, G., Solheim, J., Stang, E., Prydz, H., 2003. Mutants of the protein serine kinase PSKH1 disassemble the Golgi apparatus. *Exp. Cell Res.* 291, 299–312.
- Bullard, B., Garcia, T., Benes, V., Leake, M.C., Linke, W.A., Oberhauser, A.F., 2006. The molecular elasticity of the insect flight muscle proteins projectin and kettin. *Proc. Natl. Acad. Sci. U. S. A.* 103, 4451–4456.
- Burke, R.D., Osborne, L., Wang, D., Murabe, N., Yaguchi, S., Nakajima, Y., 2006. Neuron-specific expression of a synaptotagmin gene in the sea urchin *Strongylocentrotus purpuratus*. *J. Comp. Neurol.* 496, 244–251.
- Burnett, G., Kennedy, E.P., 1954. The enzymatic phosphorylation of proteins. *J. Biol. Chem.* 211, 969–980.
- Caenepeel, S., Charyczak, G., Sudarsanam, S., Hunter, T., Manning, G., 2004. The Mouse Kinome: Discovery and comparative genomics of all mouse protein kinases. *PNAS* 101 (32), 11707–11712.
- Capes-Davis, A., Tolhurst, O., Dunn, J.M., Jeffrey, P.L., 2005. Expression of doublecortin (DCX) and doublecortin-like kinase (DCLK) within the developing chick brain. *Dev. Dyn.* 232, 457–467.
- Castagna, M., Takai, Y., Kaibuchi, K., Sano, K., Kikkawa, U., Nishizuka, Y., 1982. Direct activation of calcium-activated, phospholipid-dependent protein kinase by tumor-promoting phorbol esters. *J. Biol. Chem.* 257, 7847–7851.
- Champion, A., Kreis, M., Mockaitis, K., Picaud, A., Henry, Y., 2004. Arabidopsis kinome: after the casting. *Funct. Integr. Genomics* 4, 163–187.
- Chou, Y.H., Rebhun, L.I., 1986. Purification and characterization of a sea urchin egg Ca²⁺-calmodulin-dependent kinase with myosin light chain phosphorylating activity. *J. Biol. Chem.* 261, 5389–5395.
- Cohen, P., 2002. Protein kinases—the major drug targets of the twenty-first century? *Nat. Rev., Drug Discov.* 1, 309–315.
- Collett, M.S., Brugge, J.S., Erikson, R.L., 1978. Characterization of a normal avian cell protein related to the avian sarcoma virus transforming gene product. *Cell* 15, 1363–1369.
- Croce, J., Duloquin, L., Lhomond, G., McClay, D.R., Gache, C., 2006. Frizzled5/8 is required in secondary mesenchyme cells to initiate archenteron invagination during sea urchin development. *Development* 133, 547–557.
- Delalande, C., Belle, R., Cormier, P., Mulner-Lorillon, O., 1999. Transient increase of a protein kinase activity identified to CK2 during sea urchin development. *Biochem. Biophys. Res. Commun.* 266, 425–431.
- Dickey-Sims, C., Robertson, A.J., Rupp, D.E., McCarthy, J.J., Coffman, J.A., 2005. Runx-dependent expression of PKC is critical for cell survival in the sea urchin embryo. *BMC Biol.* 3, 18.
- Dougherty, J.D., Garcia, A.D., Nakano, I., Livingstone, M., Norris, B., Polakiewicz, R., Wexler, E.M., Sofroniew, M.V., Kornblum, H.I., Geschwind, D.H., 2005. PBK/TOPK, a proliferating neural progenitor-specific mitogen-activated protein kinase kinase. *J. Neurosci.* 25, 10773–10785.
- Dudley, D.T., Pang, L., Decker, S.J., Bridges, A.J., Saltiel, A.R., 1995. A synthetic inhibitor of the mitogen-activated protein kinase cascade. *Proc. Natl. Acad. Sci. U. S. A.* 92, 7686–7689.
- Edelman, A.M., Kim, W.Y., Higgins, D., Goldstein, E.G., Oberdoerster, M., Sigurdson, W., 2005. Doublecortin kinase-2, a novel doublecortin-related protein kinase associated with terminal segments of axons and dendrites. *J. Biol. Chem.* 280, 8531–8543.
- Elphick, M.R., Melarange, R., 2001. Neural control of muscle relaxation in echinoderms. *J. Exp. Biol.* 204, 875–885.
- Fernandez-Guerra, A., Aze, A., Morales, J., Muner-Morillon, O., Cosson, B., Cormier, P., Bradham, C., Adams, N., Robertson, A.J., Marzluff, W.F., Coffman, J.A., Genevriere, A.-M., 2006. Cell cycle control and DNA metabolism. *Dev. Biol.* (this issue).
- Fernandez-Serra, M., Consoles, C., Livigni, A., Arnone, M.I., 2004. Role of the

- ERK-mediated signaling pathway in mesenchyme formation and differentiation in the sea urchin embryo. *Dev. Biol.* 268, 384–402.
- Futreal, P.A., Coin, L., Marshall, M., Down, T., Hubbard, T., Wooster, R., Rahman, N., Stratton, M.R., 2004. A census of human cancer genes. *Nat. Rev., Cancer* 4, 177–183.
- Ge, B., Gram, H., Di Padova, F., Huang, B., New, L., Ulevitch, R.J., Luo, Y., Han, J., 2002. MAPKK-independent activation of p38alpha mediated by TAB1-dependent autophosphorylation of p38alpha. *Science* 295, 1291–1294.
- Giusti, A.F., O'Neill, F.J., Yamasu, K., Foltz, K.R., Jaffe, L.A., 2003. Function of a sea urchin egg Src family kinase in initiating Ca²⁺ release at fertilization. *Dev. Biol.* 256, 367–378.
- Goldberg, J.M., Manning, G., Liu, A., Fey, P., Pilcher, K.E., Xu, Y., Smith, J.L., 2006. The dictyostelium kinome-analysis of the protein kinases from a simple model organism. *PLoS Genet.* 2, e38.
- Hanks, S.K., 2003. Genomic analysis of the eukaryotic protein kinase superfamily: a perspective. *Genome Biol.* 4, 111.
- Hanks, S.K., Hunter, T., 1995. Protein kinases 6. The eukaryotic protein kinase superfamily: kinase (catalytic) domain structure and classification. *FASEB J.* 9, 576–596.
- Harden, N., Yap, S.F., Chiam, M.A., Lim, L., 1993. A *Drosophila* gene encoding a protein with similarity to diacylglycerol kinase is expressed in specific neurons. *Biochem. J.* 289 (Pt. 2), 439–444.
- Heinecke, J.W., Meier, K.E., Lorenzen, J.A., Shapiro, B.M., 1990. A specific requirement for protein kinase C in activation of the respiratory burst oxidase of fertilization. *J. Biol. Chem.* 265, 7717–7720.
- Heitman, J., Movva, N.R., Hall, M.N., 1991. Targets for cell cycle arrest by the immunosuppressant rapamycin in yeast. *Science* 253, 905–909.
- Hopkins, A.L., Groom, C.R., 2002. The druggable genome. *Nat. Rev., Drug Discov.* 1, 727–730.
- Hoshijima, M., 2006. Mechanical stress-strain sensors embedded in cardiac cytoskeleton: Z disk, titin, and associated structures. *Am. J. Physiol.: Heart Circ. Physiol.* 290, H1313–H1325.
- Hughes, A.L., 1996. Evolution of the src-related protein tyrosine kinases. *J. Mol. Evol.* 42, 247–256.
- Johnson, L.N., Noble, M.E., Owen, D.J., 1996. Active and inactive protein kinases: structural basis for regulation. *Cell* 85, 149–158.
- Kumano, M., Foltz, K.R., 2003. Inhibition of mitogen activated protein kinase signaling affects gastrulation and spiculogenesis in the sea urchin embryo. *Dev. Growth Differ.* 45, 527–542.
- Kumano, M., Carroll, D.J., Denu, J.M., Foltz, K.R., 2001. Calcium-mediated inactivation of the MAP kinase pathway in sea urchin eggs at fertilization. *Dev. Biol.* 236, 244–257.
- Lapraz, F., Rottinger, E., Duboc, V., Range, R., Duloquin, L., Walton, K., Wu, S.-Y., Bradham, C., Loza-Coll, M.A., Wilson, K., McClay, D.R., Gache, C., Lepage, T., 2006. Genes for receptor tyrosine kinases and TGF signaling pathways encoded in the sea urchin genome. *Dev. Biol.* (this issue).
- Lee, J.C., Laydon, J.T., McDonnell, P.C., Gallagher, T.F., Kumar, S., Green, D., McNulty, D., Blumenthal, M.J., Heys, J.R., Landvatter, S.W., et al., 1994. A protein kinase involved in the regulation of inflammatory cytokine biosynthesis. *Nature* 372, 739–746.
- Lehtonen, S., Ryan, J.J., Kudlicka, K., Iino, N., Zhou, H., Farquhar, M.G., 2005. Cell junction-associated proteins IQGAP1, MAGI-2, CASK, spectrins, and alpha-actinin are components of the nephrin multiprotein complex. *Proc. Natl. Acad. Sci. U. S. A.* 102, 9814–9819.
- Leonard, C.J., Aravind, L., Koonin, E.V., 1998. Novel families of putative protein kinases in bacteria and archaea: evolution of the “eukaryotic” protein kinase superfamily. *Genome Res.* 8, 1038–1047.
- Lin, P.T., Gleeson, J.G., Corbo, J.C., Flanagan, L., Walsh, C.A., 2000. DCAMKL1 encodes a protein kinase with homology to doublecortin that regulates microtubule polymerization. *J. Neurosci.* 20, 9152–9161.
- Lisman, J., 1994. The CaM kinase II hypothesis for the storage of synaptic memory. *Trends Neurosci.* 17, 406–412.
- Litchfield, D.W., 2003. Protein kinase CK2: structure, regulation and role in cellular decisions of life and death. *Biochem. J.* 369, 1–15.
- Liu, J., Farmer Jr., J.D., Lane, W.S., Friedman, J., Weissman, I., Schreiber, S.L., 1991. Calcineurin is a common target of cyclophilin–cyclosporin A and FKBP–FK506 complexes. *Cell* 66, 807–815.
- Livingston, B.T., Wilt, F.H., 1992. Phorbol esters alter cell fate during development of sea urchin embryos. *J. Cell Biol.* 119, 1641–1648.
- Livingston, B.T., VanWinkle, C.E., Kinsey, W.H., 1998. Protein tyrosine kinase activity following fertilization is required to complete gastrulation, but not for initial differentiation of endoderm and mesoderm in the sea urchin embryo. *Dev. Biol.* 193, 90–99.
- Mann, M., Ong, S.E., Gronborg, M., Steen, H., Jensen, O.N., Pandey, A., 2002. Analysis of protein phosphorylation using mass spectrometry: deciphering the phosphoproteome. *Trends Biotechnol.* 20, 261–268.
- Manning, G., Caenepeel, S., 2005. Encyclopedia of protein kinases in human diseases. Catalog Reference Manual. Cell Signaling Technology, Beverly, MA. www.cellsignaling.com.
- Manning, G., Plowman, G.D., Hunter, T., Sudarsanam, S., 2002a. Evolution of protein kinase signaling from yeast to man. *Trends Biochem. Sci.* 27, 514–520.
- Manning, G., Whyte, D.B., Martinez, R., Hunter, T., Sudarsanam, S., 2002b. The protein kinase complement of the human genome. *Science* 298, 1912–1934.
- Marin, O., Bustos, V.H., Cesaro, L., Meggio, F., Pagano, M.A., Antonelli, M., Allende, C.C., Pinna, L.A., Allende, J.E., 2003. A noncanonical sequence phosphorylated by casein kinase 1 in beta-catenin may play a role in casein kinase 1 targeting of important signaling proteins. *Proc. Natl. Acad. Sci. U. S. A.* 100, 10193–10200.
- Meggio, F., Pinna, L.A., 2003. One-thousand-and-one substrates of protein kinase CK2? *FASEB J.* 17, 349–368.
- Miller, M.A., Malik, I.A., Shenk, M.A., Steele, R.E., 2000. The Src/Csk regulatory circuit arose early in metazoan evolution. *Oncogene* 19, 3925–3930.
- Morales, J., Mulner-Lorillon, O., Cosson, B., Morin, E., Belle, R., Bradham, C.A., Beane, W.S., Cormier, P., 2006. Translational control genes in the sea urchin genome. *Dev. Biol.* (this issue).
- Morrison, D.K., Murakami, M.S., Cleghon, V., 2000. Protein kinases and phosphatases in the *Drosophila* genome. *J. Cell Biol.* 150, F57–F62.
- Moser, K., White, F.M., 2006. Phosphoproteomic analysis of rat liver by high capacity IMAC and LC-MS/MS. *J. Proteome Res.* 5, 98–104.
- Mujica, A.O., Brauksiepe, B., Saaler-Reinhardt, S., Reuss, S., Schmidt, E.R., 2005. Differential expression pattern of the novel serine/threonine kinase, STK33, in mice and men. *FEBS J.* 272, 4884–4898.
- Nakajima, Y., Kaneko, H., Murray, G., Burke, R.D., 2004. Divergent patterns of neural development in larval echinoids and asteroids. *Evol. Dev.* 6, 95–104.
- O'Neill, F.J., Gillett, J., Foltz, K.R., 2004. Distinct roles for multiple Src family kinases at fertilization. *J. Cell Sci.* 117, 6227–6238.
- Parker, P.J., Murray-Rust, J., 2004. PKC at a glance. *J. Cell Sci.* 117, 131–132.
- Pearson, G., Robinson, F., Beers Gibson, T., Xu, B.E., Karandikar, M., Berman, K., Cobb, M.H., 2001. Mitogen-activated protein (MAP) kinase pathways: regulation and physiological functions. *Endocr. Rev.* 22, 153–183.
- Philipova, R., Whitaker, M., 2005. Active ERK1 is dimerized in vivo: bisphosphodimers generate peak kinase activity and monophosphodimers maintain basal ERK1 activity. *J. Cell Sci.* 118, 5767–5776.
- Philipova, R., Kisielewska, J., Lu, P., Larman, M., Huang, J.Y., Whitaker, M., 2005a. ERK1 activation is required for S-phase onset and cell cycle progression after fertilization in sea urchin embryos. *Development* 132, 579–589.
- Philipova, R., Larman, M.G., Leckie, C.P., Harrison, P.K., Groigno, L., Whitaker, M., 2005b. Inhibiting MAP kinase activity prevents calcium transients and mitosis entry in early sea urchin embryos. *J. Biol. Chem.* 280, 24957–24967.
- Plowman, G.D., Sudarsanam, S., Bingham, J., Whyte, D., Hunter, T., 1999. The protein kinases of *Caenorhabditis elegans*: a model for signal transduction in multicellular organisms. *Proc. Natl. Acad. Sci. U. S. A.* 96, 13603–13610.
- Price, M.A., 2006. CKI, there's more than one: casein kinase I family members in Wnt and Hedgehog signaling. *Genes Dev.* 20, 399–410.
- Raitano, A.B., Whang, Y.E., Sawyers, C.L., 1997. Signal transduction by wild-type and leukemogenic Abl proteins. *Biochim. Biophys. Acta* 1333, F201–F216.
- Rottinger, E., Besnardeau, L., Lepage, T., 2004. A Raf/MEK/ERK signaling pathway is required for development of the sea urchin embryo micromere

- lineage through phosphorylation of the transcription factor Ets. *Development* 131, 1075–1087.
- Roux, M.M., Townley, I.K., Raisch, M., Reade, A., Bradham, C.A., Humphreys, G., Gunaratne, H.J., Killian, C.E., Moy, G., Su, Y.-H., Etensohn, C.A., Wilt, F., Vacquier, V.D., Wessel, G., Foltz, K.R., 2006. A functional genomic and proteomic perspective of sea urchin calcium signaling and egg activation. *Dev. Biol.* (this issue).
- Samanta, M.P., Tongprasit, W., Istrail, S., Cameron, A., Tu, Q., Davidson, E.H., Stolc, V., 2006. A high-resolution transcriptome map of the sea urchin embryo. *Science* (in press).
- Sanjo, H., Kawai, T., Akira, S., 1998. DRAKs, novel serine/threonine kinases related to death-associated protein kinase that trigger apoptosis. *J. Biol. Chem.* 273, 29066–29071.
- Sebolt-Leopold, J.S., Dudley, D.T., Herrera, R., Van Becelaere, K., Wiland, A., Gowan, R.C., Tecle, H., Barrett, S.D., Bridges, A., Przybranowski, S., Leopold, W.R., Saltiel, A.R., 1999. Blockade of the MAP kinase pathway suppresses growth of colon tumors in vivo. *Nat. Med.* 5, 810–816.
- Shuster, C.B., Burgess, D.R., 1999. Parameters that specify the timing of cytokinesis. *J. Cell Biol.* 146, 981–992.
- Smith, C.I., Islam, T.C., Mattsson, P.T., Mohamed, A.J., Nore, B.F., Vihinen, M., 2001. The Tec family of cytoplasmic tyrosine kinases: mammalian Btk, Bmx, Itk, Tec, Txk and homologs in other species. *Bioessays* 23, 436–446.
- Soderling, T.R., Stull, J.T., 2001. Structure and regulation of calcium/calmodulin-dependent protein kinases. *Chem. Rev.* 101, 2341–2352.
- Song, H., Shen, Y., Gibbs, R., Weinstock, G., Sodergren, E., 2006. The assembly of the sea urchin genome. *Dev. Biol.* (this issue).
- Stein, P.L., Vogel, H., Soriano, P., 1994. Combined deficiencies of Src, Fyn, and Yes tyrosine kinases in mutant mice. *Genes Dev.* 8, 1999–2007.
- Stephens, S., Beyer, B., Balthazar-Stablein, U., Duncan, R., Kostacos, M., Lukoma, M., Green, G.R., Poccia, D., 2002. Two kinase activities are sufficient for sea urchin sperm chromatin decondensation in vitro. *Mol. Reprod. Dev.* 62, 496–503.
- Swofford, D.L., 1998. PAUP*: Phylogenetic Analysis Using Parsimony (and Other Methods). Sinauer Associates, Sutherland, MA.
- Thomas, S.M., Brugge, J.S., 1997. Cellular functions regulated by Src family kinases. *Annu. Rev. Cell Dev. Biol.* 13, 513–609.
- Thompson, J.D., Gibson, T.J., Plewniak, F., Jeanmougin, F., Higgins, D.G., 1997. The CLUSTAL_X windows interface: flexible strategies for multiple sequence alignment aided by quality analysis tools. *Nucleic Acids Res.* 25, 4876–4882.
- Tombes, R.M., Faison, M.O., Turbeville, J.M., 2003. Organization and evolution of multifunctional Ca(2+)/CaM-dependent protein kinase genes. *Gene* 322, 17–31.
- Topham, M.K., 2006. Signaling roles of diacylglycerol kinases. *J. Cell. Biochem.* 97, 474–484.
- Whitaker, M., 2006. Calcium at fertilization and in early development. *Physiol. Rev.* 86, 25–88.
- Xu, W., Doshi, A., Lei, M., Eck, M.J., Harrison, S.C., 1999. Crystal structures of c-Src reveal features of its autoinhibitory mechanism. *Mol. Cell* 3, 629–638.
- Yaguchi, S., Yaguchi, J., Burke, R.D., 2006. Specification of ectoderm restricts the size of the animal plate and patterns neurogenesis in sea urchin embryos. *Development* 133, 2337–2346.
- Zhang, W.L., Huitorel, P., Glass, R., Fernandez-Serra, M., Arnone, M.I., Chiri, S., Picard, A., Ciapa, B., 2005. A MAPK pathway is involved in the control of mitosis after fertilization of the sea urchin egg. *Dev. Biol.* 282, 192–206.
- Zhang, L., Weinstock, G., Gibbs, R., Sodergren, E., 2006. Annotation of the sea urchin genome. *Dev. Biol.* (this issue).
- Zolnierowicz, S., Bollen, M., 2000. Protein phosphorylation and protein phosphatases. De Panne, Belgium, September 19–24, 1999. *EMBO J.* 19, 483–488.